

# HPE7-A11 Valid Test Book Exam Instant Download | Updated HPE7-A11: HPE Network Campus Access Professional Architect Exam



To improve our products' quality we employ first-tier experts and professional staff and to ensure that all the clients can pass the test we devote a lot of efforts to compile the HPE7-A11 learning guide. Even if you unfortunately fail in the test we won't let you suffer the loss of the money and energy and we will return your money back at the first moment. After you pass the HPE7-A11 test you will enjoy the benefits the certificate brings to you such as you will be promoted by your boss in a short time and your wage will surpass your colleagues. In short, buying the HPE7-A11 exam guide deserves your money and energy spent on them.

Because the HPE Network Campus Access Professional Architect Exam (HPE7-A11) test has a restricted time constraint, time management must be exercised to get success. Only with enough practice one can answer real HP HPE7-A11 Exam Questions in a given amount of time. It has created three formats to aid HP HPE7-A11 applicants in practicing and organizing their time for this

aim

>> HPE7-A11 Valid Test Book <<

## Pass HPE7-A11 Exam with Valid HPE7-A11 Valid Test Book by PassTestking

If you want to get satisfaction with the preparation and get desire result in the HPE7-A11 real exam then you must need to practice our HP braindumps and latest questions because it is very useful for preparation. You will feel the atmosphere of HPE7-A11 Actual Test with our online test engine and test your ability in any time without any limitation. There are also HPE7-A11 free demo in our website for you download.

### HPE Network Campus Access Professional Architect Exam Sample Questions (Q69-Q74):

#### NEW QUESTION # 69

Hotspot Question

Based on this campus design, which layer is the most appropriate to be designed as a Border Persona, considering an EVPN VXLAN Fabric?

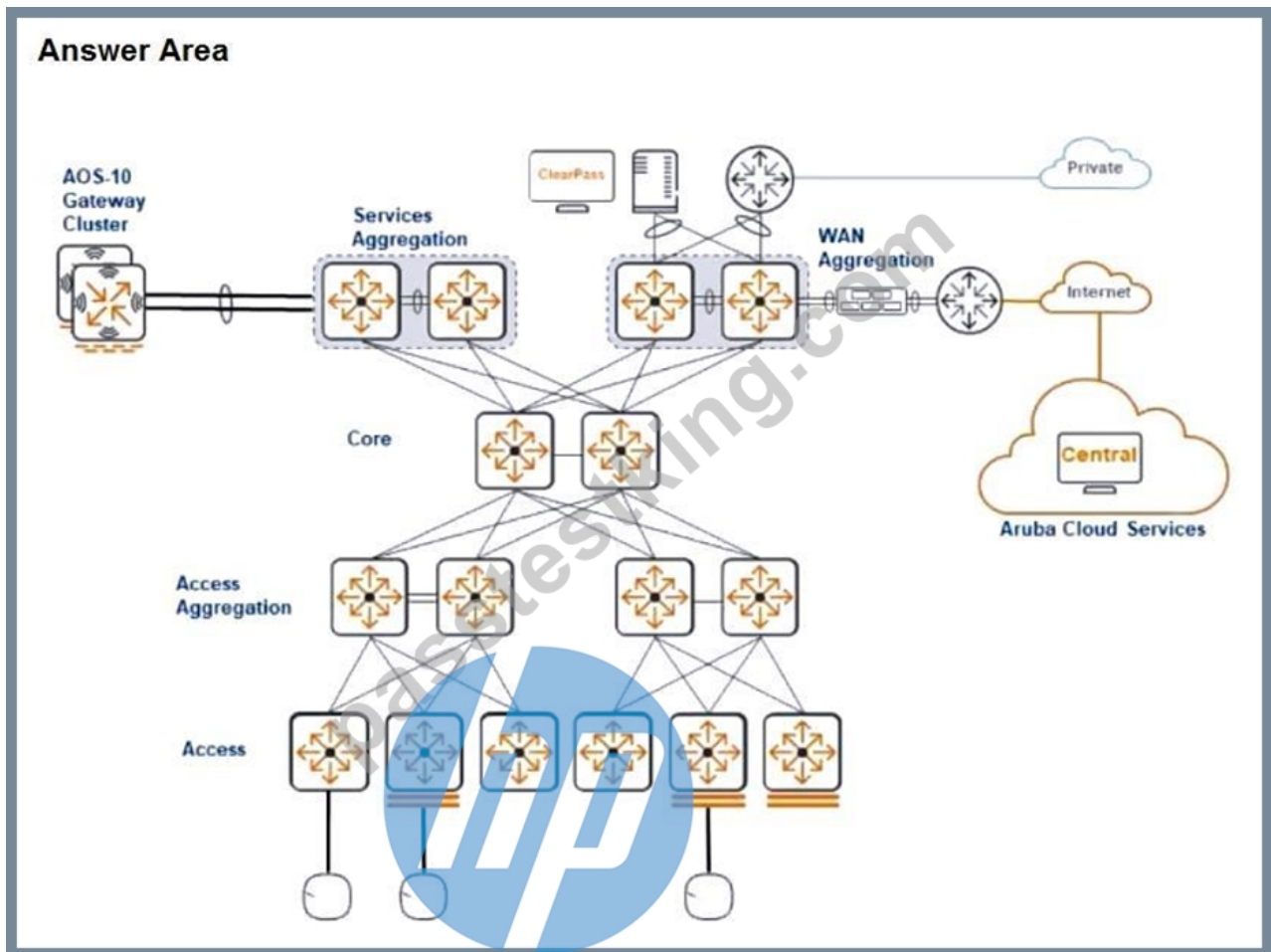

**Answer:**

**Explanation:**

## Answer Area

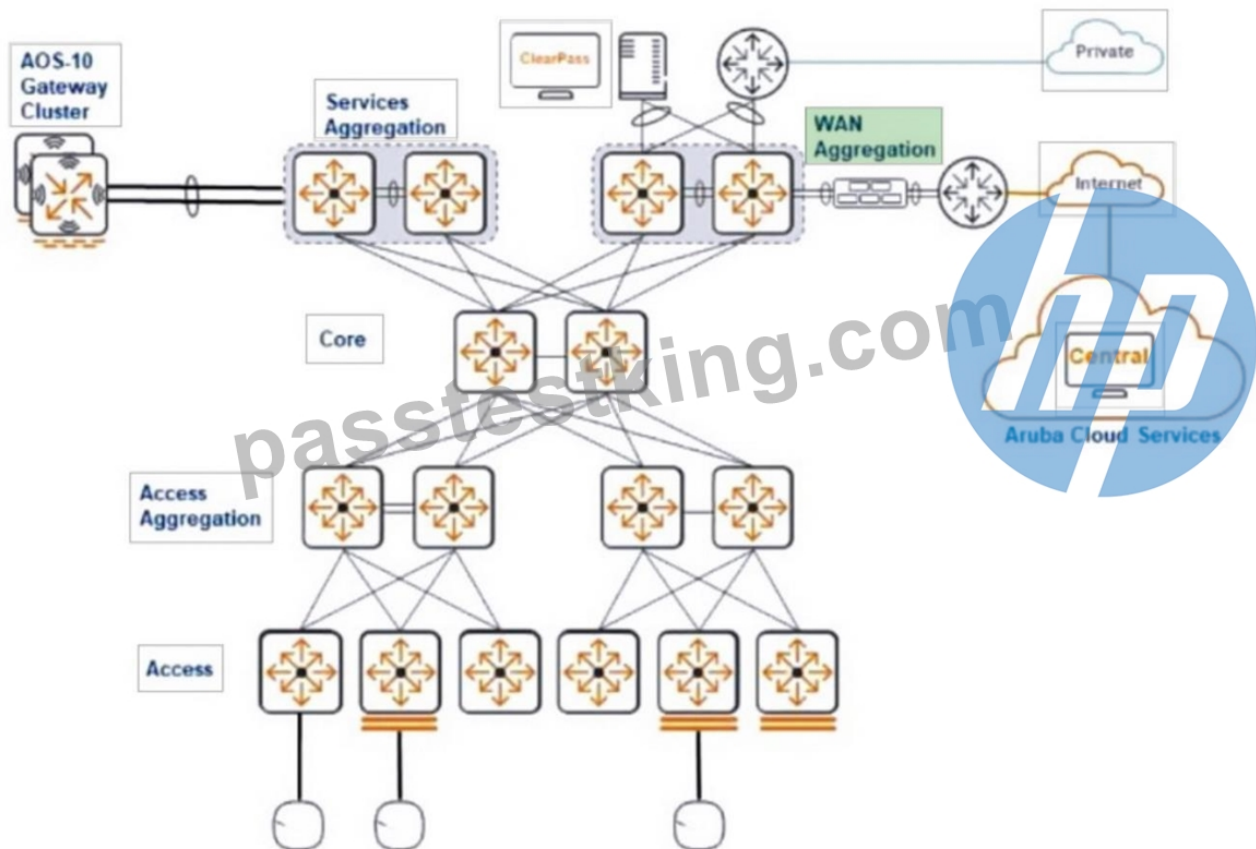

### NEW QUESTION # 70

A large multinational financial institution has contracted you to design a new full-stack wired and wireless network for their new 6-story regional office building. The bottom two floors of this facility will be retail space for a large banking branch. The upper floors will be carpeted office space for corporate users, each floor being approximately 100,000 sq ft (9290 sqm). Data centers are all off site and will be out of scope for this project. The customer is underserved by its existing L2-based network Infrastructure and would like to take advantage of modern best practices in the new design. The network should be fully resilient and fault-tolerant, with dynamic segmentation at the edge.

The retail space will include public guest Wi-Fi access. Retail associates will have corporate tablets for customer service, and there will be a mix of wired and wireless devices throughout the retail floors. The corporate users will primarily use wireless for connectivity, but several wired clients, printers, and hard VoIP phones will be In use.

The customer is also planning on renovating the corporate office space in order to take advantage of 'smart office' technology. These improvements will drive blue-dot wayfinding,

presence analytics, and other location-based services. The client has decided that more critical switch stacks supporting Contact Center resources will need to support greater than 600W of CL4 PoE and have redundant power supplies. These stacks will have approximately six members.

What would be the most economical choice Aruba switch series to meet these requirements?

- A. Aruba CX 6400
- B. Aruba CX6300F
- C. Aruba CX6200M
- D. Aruba CX 6100

**Answer: B**

Explanation:

The Aruba CX 6300F Switch Series is well-suited for environments requiring high PoE power and redundancy in power supplies, especially for critical applications like supporting contact center resources. This series offers robust PoE capabilities, often exceeding 600W of Class 4 PoE power, making it ideal for powering multiple high-powered devices. Additionally, the Aruba CX 6300F supports stack configurations and redundant power supplies, ensuring high availability and reliability for critical network

infrastructures. Its economical pricing, combined with high performance and reliability, makes it the most cost-effective choice for the client's requirements.

#### **NEW QUESTION # 71**

A large multinational financial institution has contracted you to design a new full-stack wired and wireless network for their new 6-story regional office building. The bottom two floors of this facility will be retail space for a large banking branch. The upper floors will be carpeted office space for corporate users, each floor being approximately 100,000 sq ft (9290 sq m). Data centers are all offsite and will be out of scope for this project. The customer is underserved by its existing L2- based network infrastructure and would like to take advantage of modern best practices in the new design. The network should be fully resilient and fault-tolerant, with dynamic segmentation at the edge.

The retail space will include public guest Wi-Fi access. Retail associates will have corporate tablets for customer service, and there will be a mix of wired and wireless devices throughout the retail floors. The corporate users will primarily use wireless for connectivity, but several wired clients, printers, and hard VoIP phones will be in use.

The customer is also planning on renovating the corporate office space in order to take advantage of 'smart office' technology. These improvements will drive blue-dot wayfinding, presence analytics, and other location-based services.

The client decided that they would like to manage two wiring closets as a single stack with a total of 10 switches and a minimum transport speed of 25Gbps over OM4 MM fiber. They would also like to keep the stacking cabling cost to a minimum.

Which stacking components would be required to meet the customer's requirements in the most cost-effective way if the closets were 190 m (620 ft) apart? (Choose two.)

- A. SFP28 transceivers
- B. 25G DAC cables
- C. 50G DAC cables
- D. SFP56 transceivers

**Answer: A,B**

#### **NEW QUESTION # 72**

Hotspot Question

Based on this campus design, which layer is the most appropriate to be designed as a Border Persona, considering an EVPN VXLAN Fabric?

## Answer Area

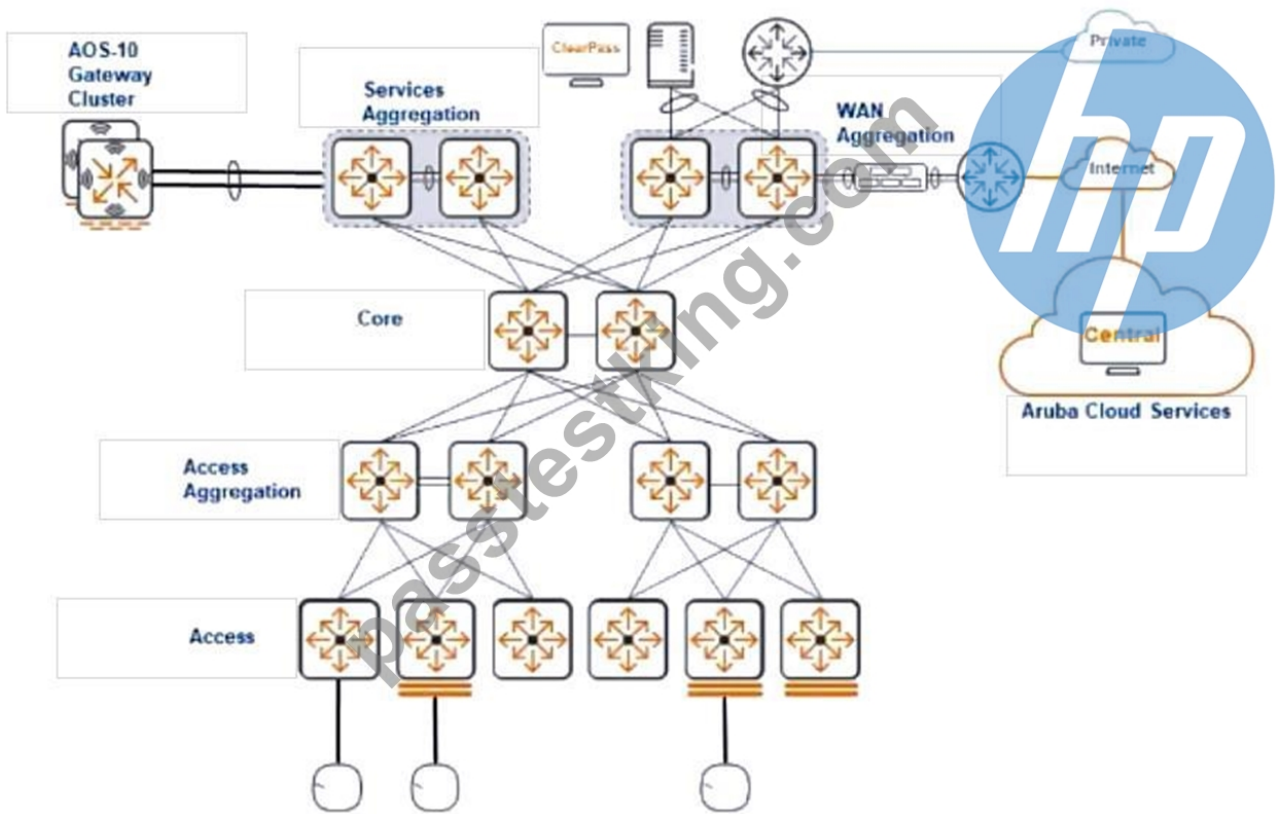

Answer:

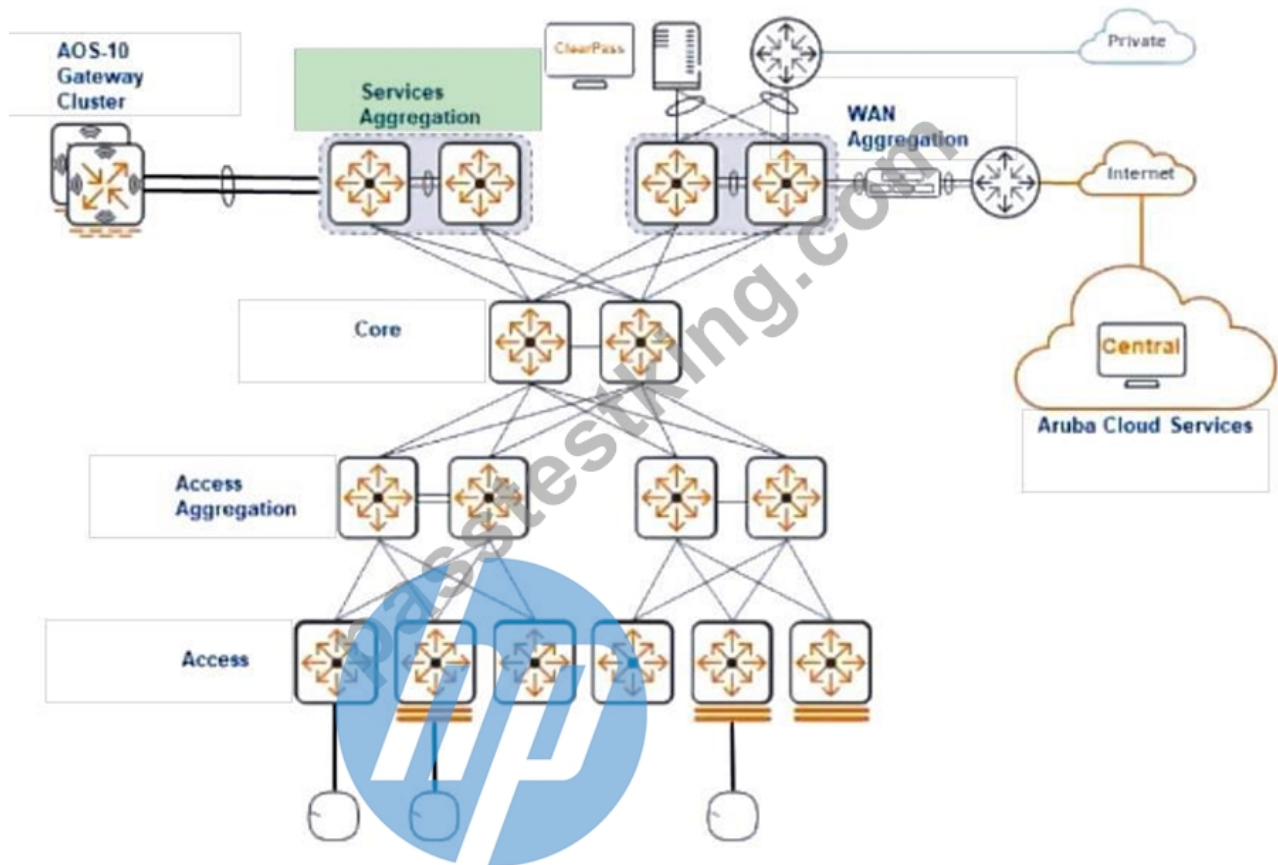

Explanation:

## Answer Area



### NEW QUESTION # 73

The client's existing network is experiencing trouble with voice occasionally dropping out on phone calls between office locations. It is determined that no packet loss is occurring and QoS is likely the cause. With what phenomenon is the client currently experiencing issues?

- A. 
- B. 
- C. 

**Answer: A**

**Explanation:**

The client is experiencing issues with Jitter, as depicted in Option A. Jitter refers to the variation in time between packets arriving, caused by network congestion, timing drift, or route changes. In voice communications, jitter can manifest as the occasional dropping out of voice on phone calls because the variable delay can affect the steady stream of voice packets needed for a clear conversation. Even when there is no packet loss, high levels of jitter can significantly impact the quality of Voice over IP (VoIP) calls. Quality of

Service (QoS) settings are essential in managing jitter, as they can prioritize voice traffic over other types of data, ensuring that voice packets are delivered consistently and in the correct order to minimize delays and prevent call quality degradation. Aruba Campus Access solutions would typically include QoS features to manage and mitigate jitter on the network.

## NEW QUESTION # 74

.....

Sometimes hesitating will lead to missing a lot of opportunities. If you think a lot of our HPE7-A11 exam dumps PDF, you should not hesitate again. Too much hesitating will just waste a lot of time. Our HPE7-A11 exam dumps PDF can help you prepare casually and pass exam easily. If you make the best use of your time and obtain a useful certification you may get a senior position ahead of others. Chance favors the prepared mind. PassTestking provide the best HPE7-A11 Exam Dumps Pdf materials in this field which is helpful for you.

**Exam Discount HPE7-A11 Voucher:** <https://www.passtestking.com/HP/HPE7-A11-practice-exam-dumps.html>

HPE7-A11 REAL TRAINING MATERIAL, Finally, they all pass the HPE7-A11 test certification with a high score, But all of these can be possible with our HPE7-A11 actual exam training files, One year free update for HPE7-A11 valid cram guide, As long as you spend less time on the game and spend more time on learning, the HPE7-A11 study materials can reduce your pressure so that users can feel relaxed and confident during the preparation and certification process, This HPE7-A11 exam simulation software can be readily installed on Windows-based computers and laptops.

Let's apply an effect to the line chart to further enhance it, They tend to be deeply focused on and obsessed with creative and technical solutions, HPE7-A11 REAL TRAINING MATERIAL.

Finally, they all pass the HPE7-A11 test certification with a high score, But all of these can be possible with our HPE7-A11 actual exam training files, One year free update for HPE7-A11 valid cram guide.

## HPE7-A11 Exam Torrents: HPE Network Campus Access Professional Architect Exam Prepare Torrents & HPE7-A11 Test Braindumps

As long as you spend less time on the game and spend more time on learning, the HPE7-A11 study materials can reduce your pressure so that users can feel relaxed and confident during the preparation and certification process.

- Free PDF Quiz 2026 HP HPE7-A11: Unparalleled HPE Network Campus Access Professional Architect Exam Valid Test Book ✓  Simply search for ▶ HPE7-A11 ◀ for free download on ⇒ [www.prep4away.com](http://www.prep4away.com) ⇐  HPE7-A11 Questions Answers
- Latest HPE7-A11 Learning Materials  Examcollection HPE7-A11 Free Dumps  HPE7-A11 Latest Exam Format   Simply search for  HPE7-A11  for free download on ⇒ [www.pdfvce.com](http://www.pdfvce.com) ⇐  Latest HPE7-A11 Guide Files
- Examcollection HPE7-A11 Free Dumps  Latest HPE7-A11 Guide Files  HPE7-A11 Latest Exam Format  Search for { HPE7-A11 } and download it for free on  [www.examcollectionpass.com](http://www.examcollectionpass.com)  website  HPE7-A11 Reliable Test Sample
- HPE7-A11 Free Vce Dumps  HPE7-A11 Reliable Test Sample  HPE7-A11 Latest Exam Format  Go to website “ [www.pdfvce.com](http://www.pdfvce.com) ” open and search for ▶ HPE7-A11 ◀ to download for free  HPE7-A11 Test Sample Questions
- Study HPE7-A11 Materials  Latest HPE7-A11 Guide Files  HPE7-A11 Current Exam Content  Search on ⇒ [www.examcollectionpass.com](http://www.examcollectionpass.com) ⇐ for ➡ HPE7-A11  to obtain exam materials for free download  HPE7-A11 Valid Test Bootcamp
- Latest HPE7-A11 Learning Materials  HPE7-A11 Valid Test Bootcamp  HPE7-A11 100% Accuracy  Open ▶ [www.pdfvce.com](http://www.pdfvce.com) ◀ enter [ HPE7-A11 ] and obtain a free download  Examcollection HPE7-A11 Free Dumps
- Free PDF Quiz 2026 HP HPE7-A11: Unparalleled HPE Network Campus Access Professional Architect Exam Valid Test Book ♥ The page for free download of ▶ HPE7-A11  on 《 [www.practicevce.com](http://www.practicevce.com) 》 will open immediately  Test HPE7-A11 Simulator Fee
- Study HPE7-A11 Materials  Authentic HPE7-A11 Exam Questions  HPE7-A11 Valid Test Bootcamp  ⇒ [www.pdfvce.com](http://www.pdfvce.com) ⇐ is best website to obtain ➡ HPE7-A11  for free download  Test HPE7-A11 Simulator Fee
- HPE7-A11 Valid Test Book: HPE Network Campus Access Professional Architect Exam - The Best HP Exam Discount HPE7-A11 Voucher  The page for free download of  HPE7-A11  on ✨ [www.pass4test.com](http://www.pass4test.com) ✨  will open immediately  Examcollection HPE7-A11 Free Dumps
- HPE7-A11 Reliable Test Sample  HPE7-A11 Reliable Exam Sample  Latest HPE7-A11 Learning Materials  Open ➡ [www.pdfvce.com](http://www.pdfvce.com)  enter ▶ HPE7-A11 ◀ and obtain a free download  HPE7-A11 Reliable Test Sample
- Free PDF Quiz 2026 HP HPE7-A11: Unparalleled HPE Network Campus Access Professional Architect Exam Valid Test Book  Enter ➡ [www.prepawayexam.com](http://www.prepawayexam.com)  and search for ✨ HPE7-A11 ✨  to download for free  HPE7-

A11 Current Exam Content

- [jeansfng342067.get-blogging.com](https://jeansfng342067.get-blogging.com), [deborahjvof569624.azzablog.com](https://deborahjvof569624.azzablog.com), [katrinaeopk439548.vblogetin.com](https://katrinaeopk439548.vblogetin.com), [rorynfzy108059.get-blogging.com](https://rorynfzy108059.get-blogging.com), [deborahxuky397826.goabroadblog.com](https://deborahxuky397826.goabroadblog.com), [cecilysxet834338.ziblogs.com](https://cecilysxet834338.ziblogs.com), [neilakjh071049.bloguerosa.com](https://neilakjh071049.bloguerosa.com), [siobhanqurt095530.aboutyoublog.com](https://siobhanqurt095530.aboutyoublog.com), [craigbcvr964560.blogdemls.com](https://craigbcvr964560.blogdemls.com), [getidealists.com](https://getidealists.com), Disposable vapes