

OGA-032 Reliable Braindumps Questions | Exam OGA-032 Questions Answers

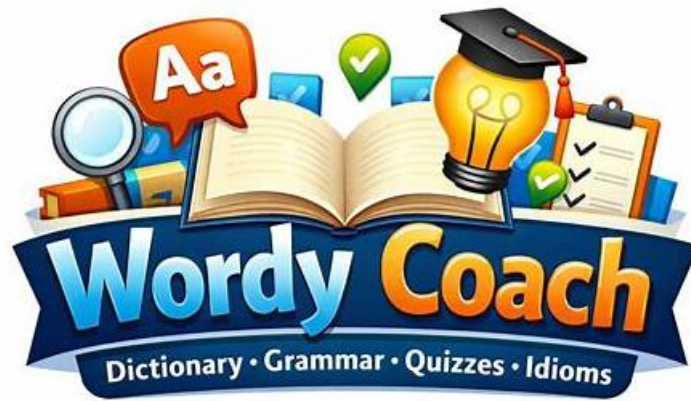

Crack the The Open Group OGA-032 Exam with Flying Colors. The The Open Group OGA-032 certification is a unique way to level up your knowledge and skills. With the Understanding ArchiMate 3 Part 2 Exam OGA-032 credential, you become eligible to get high-paying jobs in the constantly advancing tech sector. Success in the The Open Group OGA-032 examination also boosts your skills to land promotions within your current organization. Are you looking for a simple and quick way to crack the Understanding OGA-032 examination? If you are, then rely on OGA-032 Dumps.

You can adjust the speed and keep vigilant by setting a timer for the simulation test. At the same time online version of OGA-032 test preps also provides online error correction— through the statistical reporting function, it will help you find the weak links and deal with them. Of course, you can also choose two other versions. The contents of the three different versions of OGA-032 learn torrent is the same and all of them are not limited to the number of people/devices used at the same time.

>> OGA-032 Reliable Braindumps Questions <<

Pass Guaranteed Quiz 2026 Professional OGA-032: ArchiMate 3 Part 2 Exam Reliable Braindumps Questions

The DumpTorrent The Open Group OGA-032 practice test software is offered in two different types which are ArchiMate 3 Part 2 Exam (OGA-032) desktop practice test software and web-based practice test software. Both are the Prepare for your OGA-032 practice exams that will give you a real-time ArchiMate 3 Part 2 Exam (OGA-032) exam environment for quick OGA-032 exam preparation. With the OGA-032 desktop practice test software and web-based practice test software you can get an idea about the types, structure, and format of real OGA-032 exam questions.

The Open Group ArchiMate 3 Part 2 Exam Sample Questions (Q19-Q24):

NEW QUESTION # 19

Please read this scenario prior to answering the question

An airline operates a Flight Scheduling process supported by a Scheduling Engine and Crew Management application.

Flight schedules and staff availability are stored in separate databases. Both applications run in redundant server clusters connected

via dual LAN switches and independent storage arrays.
Refer to the scenario.

Which option best represents the relationships across layers?

- A. Model crew availability as a Business Actor.
- B. Model applications only as Technology Nodes.
- C. Model Flight Scheduling as a Business Process served by Application Services realized by Application Functions assigned to Application Components, accessing Data Objects, deployed on Server Nodes connected through Communication Networks to Storage Devices.
- D. Use Aggregation only for all relationships.

Answer: C

NEW QUESTION # 20

Please read this scenario prior to answering the question

The ArchiSurance enterprise document management solution plays a crucial role in supporting a large number of document types and managing a high volume of document-based transactions each day. Given its business-critical nature, the document management solution is hosted redundantly across two geographically separate data center sites: Site A and Site B. Both sites are configured identically to ensure seamless operations.

Each site has a highly available data center network (DCN) that connects to the resilient ArchiSurance wide area network (WAN).

Each claim management server is connected to its respective site's DCN, forming a converged network that interconnects servers and storage arrays. A dedicated physical storage array is allocated to the claim management application within each DCN.

Additionally, each site houses four powerful physical servers exclusively dedicated to the claim management application. Among these servers, one remains on standby at any given time, while the other three take on specific roles in hosting the document, workflow, and application engines.

The standby server is responsible for monitoring the behavior of the other servers, providing a logging and reporting service. The active servers regularly transmit data to facilitate this monitoring functionality. In the event of a server failure, the standby server steps in to perform resource reallocation, replacing the faulty server. However, this task requires manual intervention from a system administrator to reconfigure the logging and reporting service to adapt to the new environment.

Refer to the Scenario

The IT manager has asked you to model the hardware and networks that support the document management solution. This includes capturing the infrastructure components such as data center sites, servers, storage, and networks. Additionally, you are expected to outline the necessary functionality and services required to enable failover within a server cluster. Given that both data centers share an identical configuration, it is sufficient for Site B to only show the associated networking. Which of the following is the best answer?

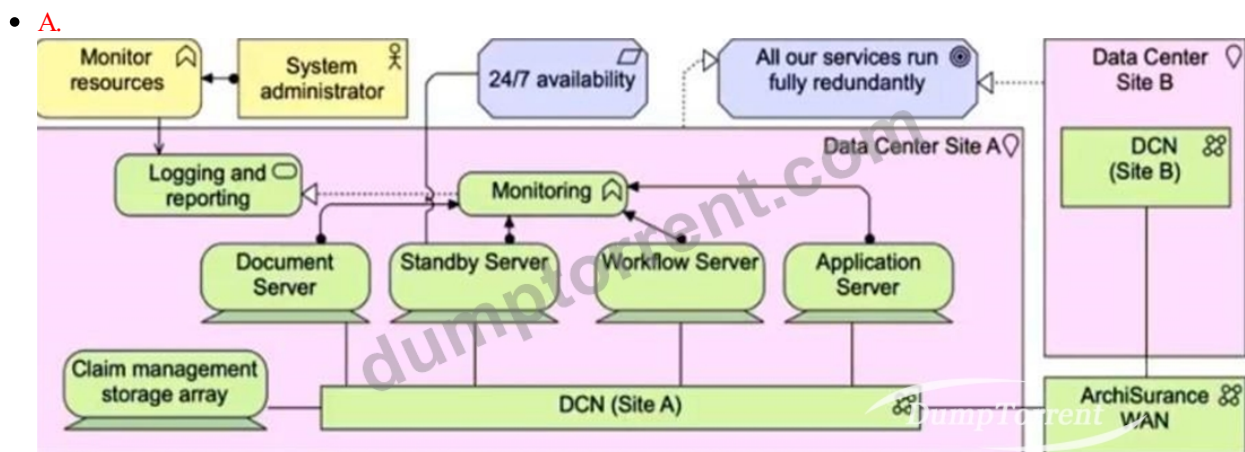

- B.

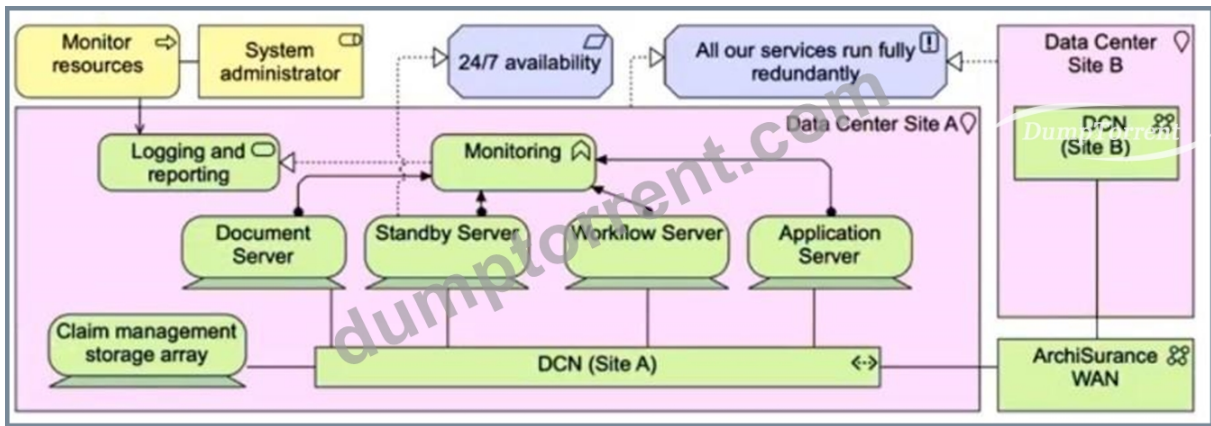

• C.

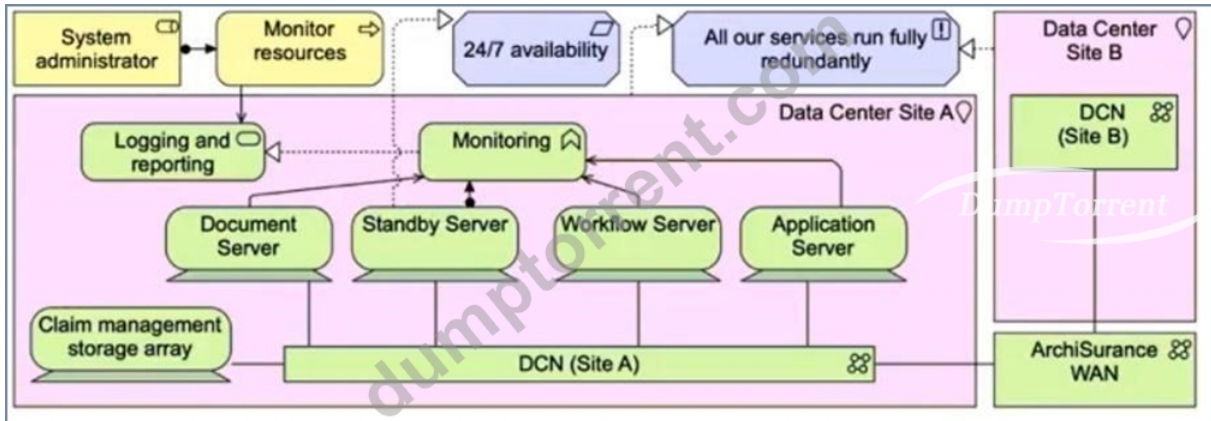

• D.

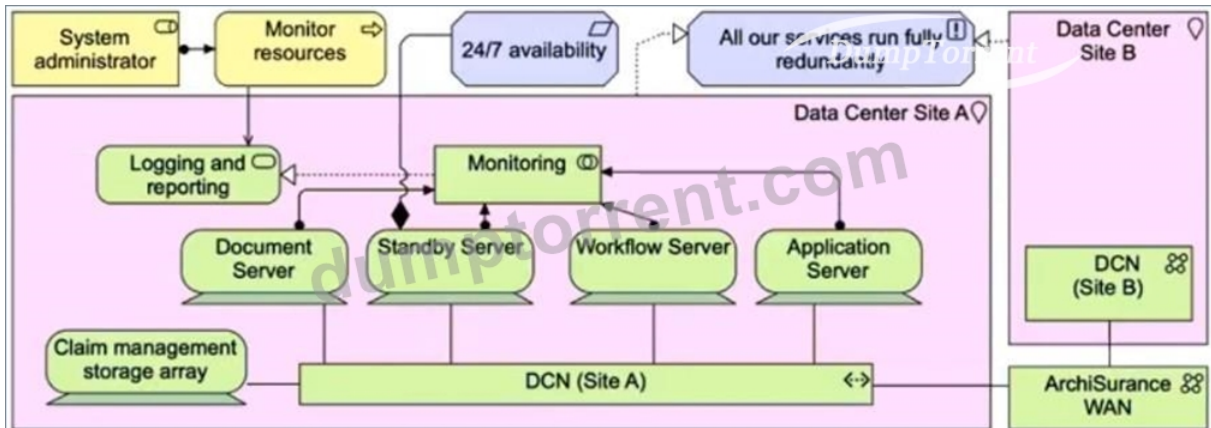

Answer: A

Explanation:

Business Layer

- System Administrator is shown as a Business Actor (stick-figure badge).
- Monitor resources is a Business Function (chevron badge) assigned to the System Administrator.

Motivation

- "24/7 availability" is modeled as a Goal,
- "All our services run fully redundantly" as a Requirement.
- Both link into the technology-layer failover design.

Technology Layer

- Monitoring is a Technology Function (up-arrow badge) realized by the standby server.
- Logging and reporting is a Technology ("infrastructure") Service (circle badge) offered by that same node.
- The four physical machines (Document, Workflow, Application, Standby Servers) are all Technology Nodes (the 3D-style server shapes).
- The claim storage is a Technology Artifact (cylinder); the DCNs and WAN are Technology Network elements.

Locations

- Both sites are captured as Location elements (the pin icon), but only Site B's networking is shown to avoid unnecessary

duplication.

Fail-over Flow

- Arrows from the active servers into the Monitoring function capture the regular "heartbeat."
- The standby node realizes Monitoring and Logging/Reporting, and a manual triggering relationship back to the System Administrator models the human re-configuration step.

NEW QUESTION # 21

Please read this scenario prior to answering the question

The ArchiSurance enterprise document management solution includes a sophisticated ecosystem of applications and technologies. Designed with a strong emphasis on high availability, it plays a vital role in providing support for a diverse range of document types and managing a substantial volume of document-based transactions on a daily basis. Recognizing its importance to the business, the document management solution is redundantly hosted at two geographically separate data center sites, both configured identically for seamless operations.

The system software at the core of the document management solution is comprised of three key modules. The Document Engine serves as a repository, facilitating document storage, retrieval, and various other operations. The Workflow Engine acts as a host for document management applications, while the Application Engine powers the most advanced and sophisticated applications within the system.

Two key factors have driven the Architecture Board's approval of a project aimed at updating this critical solution. Firstly, the supplier of the Workflow Engine has given notice of the end of support for the current software version, necessitating an upgrade. Secondly, the system administrator responsible for the Application Engine has flagged the need for hardware replacement on the server where the software is currently running. Given that the Claim Management application shares infrastructure with the Application Engine, the involvement of the system administrator responsible for this application is crucial in the project planning and execution.

Refer to the Scenario

You are the Enterprise Architect within this organization. You have been assigned the task of modeling the applications and technology for this solution, as well as outlining the motivations driving the need for its update.

Based on the scenario, which answer provides the most complete and accurate description?

- A.

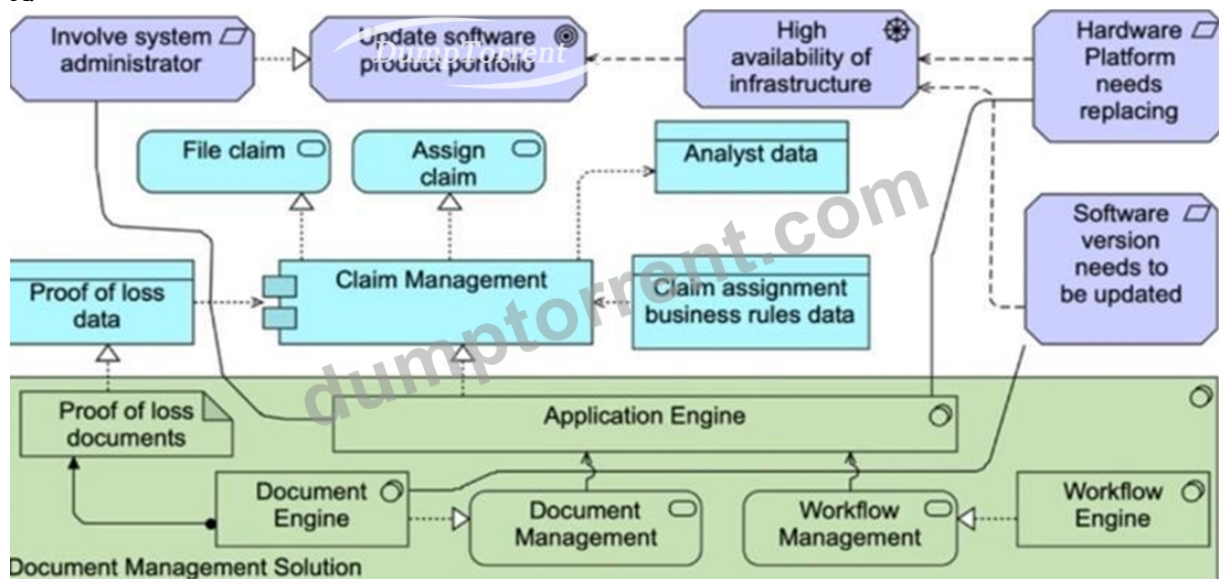

- B.

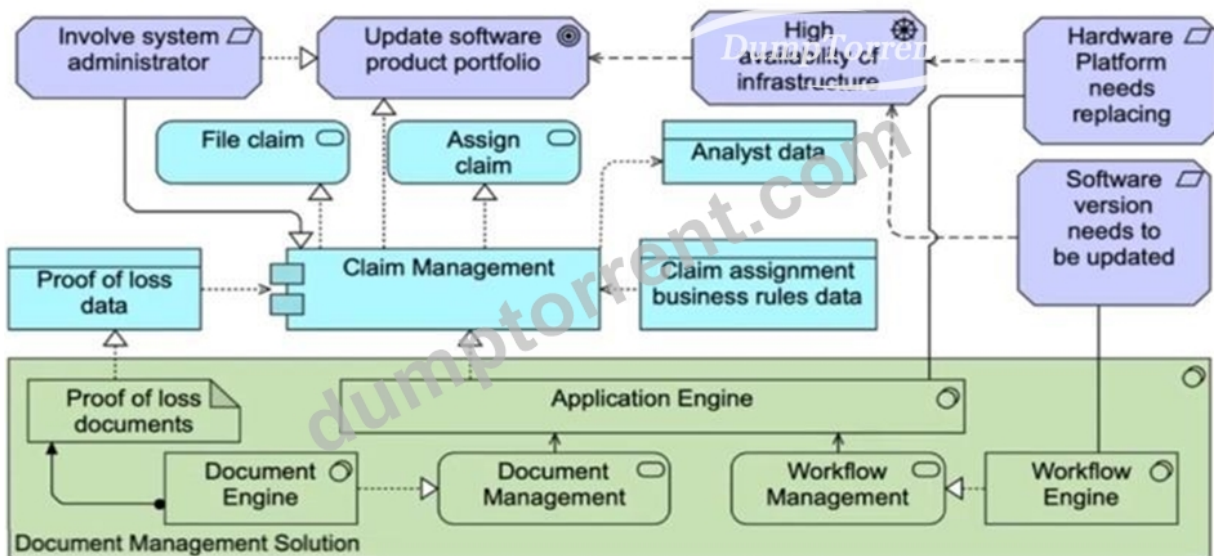

• C.

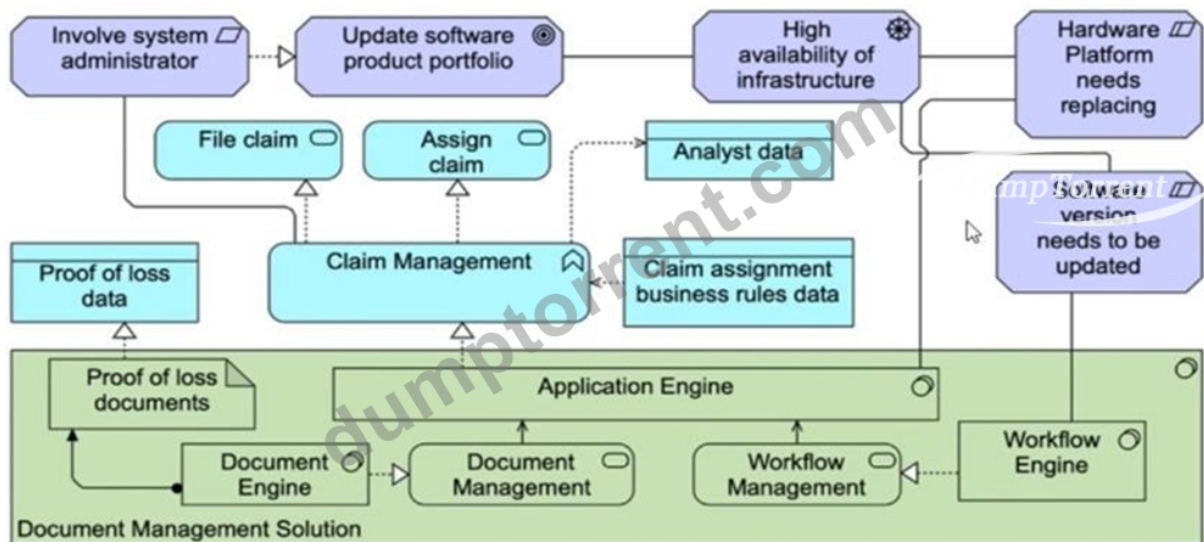

• D.

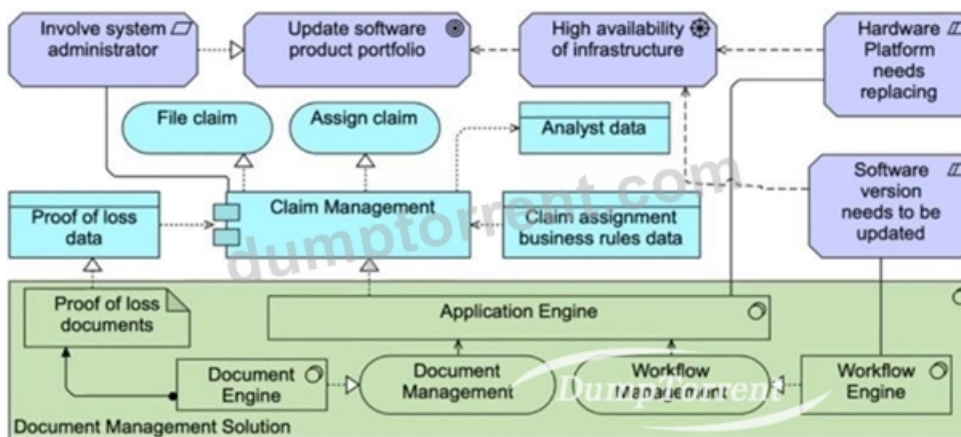

Answer: D

Explanation:

Chosen option provides the most complete and accurate representation according to the scenario:

It clearly models the motivations (e.g., "Involve system administrator," "Update software product portfolio," "High availability of infrastructure," "Hardware platform needs replacing," "Software version needs to be updated") and their relationships, capturing both the software and hardware motivations driving the project.

The business layer is represented with processes/services ("File claim," "Assign claim"), and the supporting data objects are linked appropriately (e.g., "Proof of loss data," "Analyst data," "Claim assignment business rules data").

The application layer accurately shows the main components ("Claim Management," "Application Engine," "Document Engine," "Document Management," "Workflow Management," "Workflow Engine") and their interactions, which reflects the described architecture of the document management solution.

The technology layer is represented by the green background (Document Management Solution), which contains the application components as described, showing how infrastructure supports application services.

Relationships between all layers (motivation, business, application, and technology) are clearly modeled, allowing for end-to-end traceability from motivation to implementation.

NEW QUESTION # 22

Please read this scenario prior to answering the question

ArchiAir Catering Services (ACS) manages the catering services for ArchiAir, a leading airline.

ACS is the sole catering supplier for all ArchiAir flights, and its services include full provisioning to the aircraft.

Currently, ACS operates three central production facilities, supported by distribution hubs and local pre-flight production facilities.

The central production facilities are responsible for producing standardized non-food materials (such as plates, cutlery, and boxes), non-perishable food products, and key ingredients required by the local production facilities. These materials are subsequently distributed to the distribution hubs, which also serve as warehouses for the local production facilities. Within the local production facilities, multiple production machines are utilized, each featuring dedicated workstations for chefs and quality inspectors. Most of the local production facilities employ fully automated assembly lines, including built-in packaging stations.

The loaded service trolleys are then transported to the aircraft using small lorries.

In response to investor pressure for ArchiAir to reduce its carbon footprint, the CEO of ACS has announced a plan to address this environmental concern. Subsequently, the Ministry of Social Welfare and Health has enacted a law mandating a reduction in CO2 emissions from all production facilities by the end of the year. Additionally, the airline's decision to raise ticket prices due to escalating fuel costs has led to a decrease in passenger numbers. This, in turn, impacts the volume of non-food materials required from ACS. An internal investigation has produced a report highlighting the potential benefits of centralizing production facilities and reducing the number of distribution centers. Such changes would result in lower CO2 emissions while still effectively meeting all the requirements of ArchiAir.

In addition to evaluating its supply chain to reduce its carbon footprint, ArchiAir is taking proactive steps to achieve a net zero carbon footprint for its IT operations. The Chief Information Officer (CIO) has identified two crucial requirements to support this endeavor. The first requirement involves switching to renewable energy for ACS facilities, which are often located in remote areas where traditional fuels are the primary source of energy. To align with sustainability goals, ArchiAir aims to transition these facilities to renewable energy sources. By utilizing renewable energy, ArchiAir can significantly reduce its reliance on traditional fuels and contribute to a greener operation. The second requirement pertains to the scalability of ArchiAir's IT operations, taking into account the airline's susceptibility to seasonal changes in demand. The CIO has observed notable disparities between sites that have additional blade servers and can scale their capacity, and sites that solely rely on the two mainframes housed in central facilities. A comprehensive report has revealed that the blade servers have a negligible impact on resource waste, whereas the mainframes are notorious for their power inefficiency, particularly during periods of low demand.

Refer to the Scenario

You have been asked to model the motivations for ArchiAir to achieve a net zero carbon footprint for its IT operations.

Which of the following best describes the situation described in the scenario?

- A.

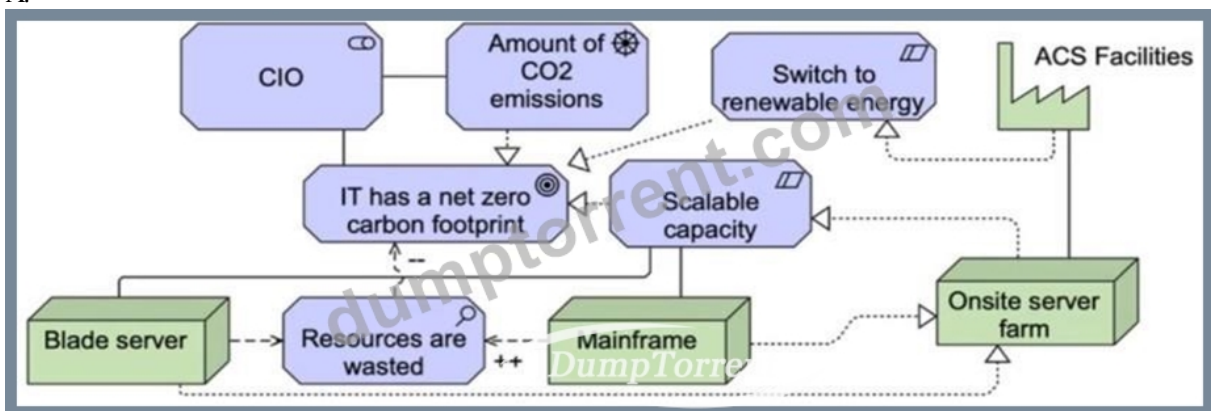

- B.

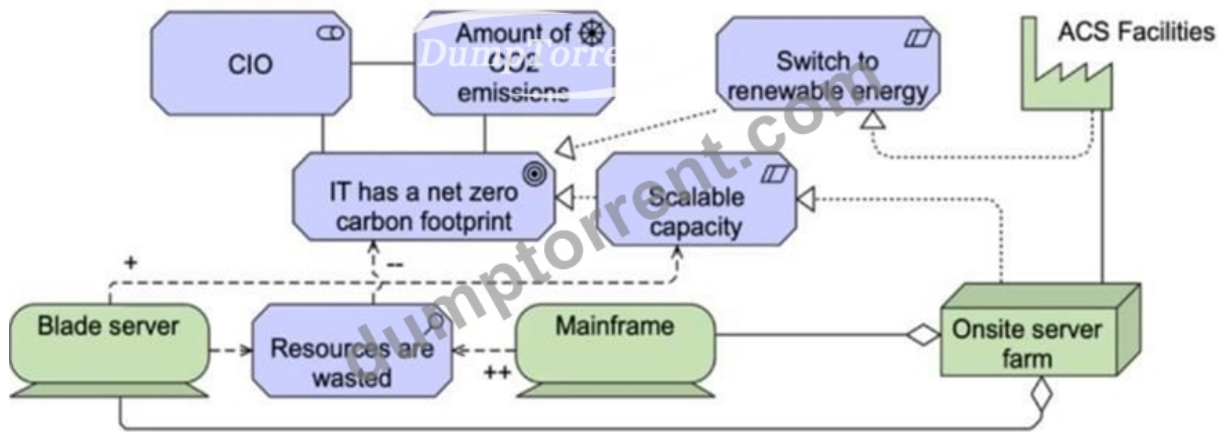

• C.

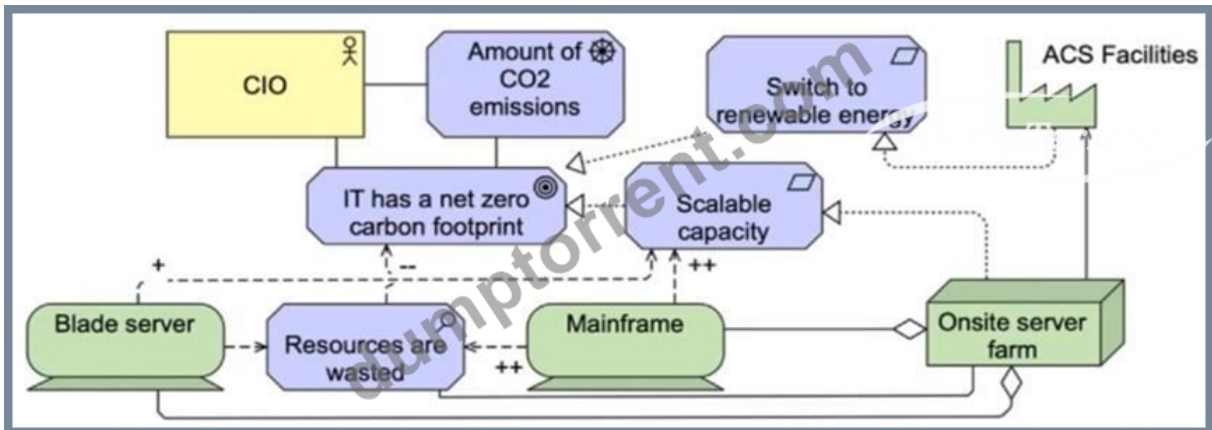

• D.

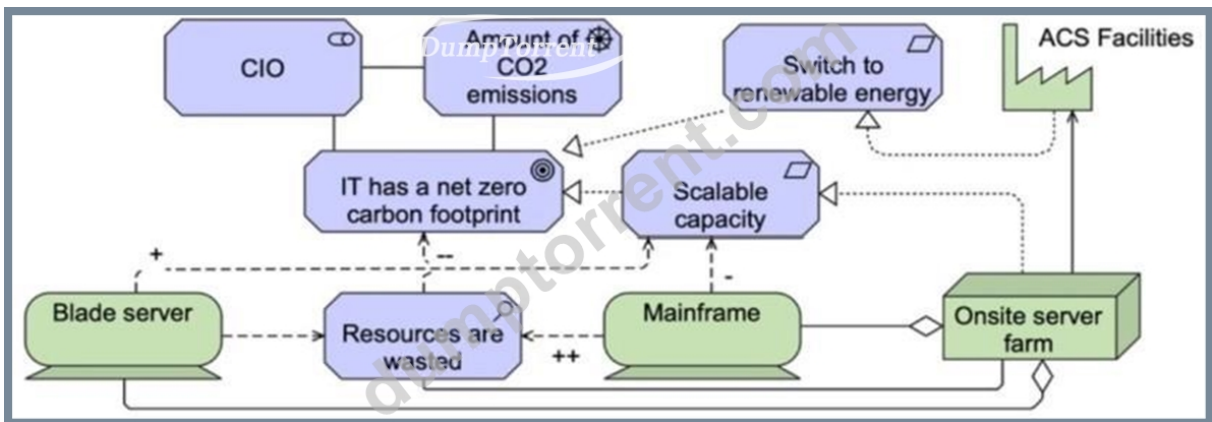

Answer: C

Explanation:

Chosen option most accurately models the motivations for ArchiAir to achieve a net zero carbon footprint for its IT operations according to the scenario:

It shows the stakeholder (CIO) with a clear concern for CO2 emissions and net zero carbon footprint, directly linked as a driver for change.

The goals and outcomes ("IT has a net zero carbon footprint") are represented and clearly connected to requirements such as "Switch to renewable energy" and "Scalable capacity." The capabilities/resources ("Blade server," "Mainframe," "Onsite server farm") and their impact on resources wasted are represented correctly using influence relationships (positive/negative impacts). The influence and realization relationships between elements correctly follow the ArchiMate Motivation and Strategy modeling standards, showing how resources, capabilities, and requirements interact to achieve the strategic goal.

The diagram demonstrates the full traceability from stakeholder motivation through goals and requirements, down to the resources and their operational impacts, which is the essence of modeling motivations in ArchiMate.

NEW QUESTION # 23

Please read this scenario prior to answering the question

ArchiSurance has decided to leverage its financial expertise by offering defined contribution retirement plans.

Each trading day, ArchiSurance submits consolidated mutual fund trading transactions to a stock exchange on behalf of its retirement plan participants.

The daily mutual fund trading cycle consists of four key processes: Transaction capture, pricing, trading and reconciliation.

Transaction capture consists of two sub-processes: manual exchange and loans and distributions (L&D). For transaction capture, retirement plan participants use an online account management application to enter manual fund exchange transactions. For L&D, plan participants use a separate application to enter requests. The L&D application determines whether the request can be fulfilled based on the mutual fund balances held in each plan balances and a set of business rules. Each day's captured manual exchange transactions accumulate in a transaction database.

ArchiSurance contracts with a third-party information service to receive a file of mutual fund prices at the close of each trading day. The pricing application uses this file to convert captured transaction into trades, and then validates each trade against the mutual fund balances held in each plan. The pricing application generates a trade file with the minimum number of trades necessary. The trading application sends this file to an external trading service.

When the trading application

receives a confirmation file back from the trading service, it causes the reconciliation application to update the plan recordkeeping database.

The account management and L&D applications are hosted on separate application server clusters. Each cluster is a physically separate host that runs application server software on a set of virtualized hosts. All of these applications use a database server infrastructure that is hosted on another separate cluster of virtualized servers also on a dedicated physical host. The pricing, consolidation, trading and reconciliation applications, however, are batch applications that run on the ArchiSurance mainframe computer. All application hosts are connected via a converged data center network (DCN), which also connects them to a storage area network (SAN) as well as a wide area network (WAN) that is used to communicate with the external trading service. The SAN includes two physically separate storage arrays, one of which holds data for all databases, and another that holds data for all files.

Refer to the Scenario

The systems analysts would like to better understand the business processes and applications for daily fund trading. You have been asked to describe the business processes and sub-processes, the applications that they use, the data objects accessed by those applications, and the external application services that access some of those data objects.

Which of the following is the best answer? Note that you are not required to model the business actors/roles.

- A.

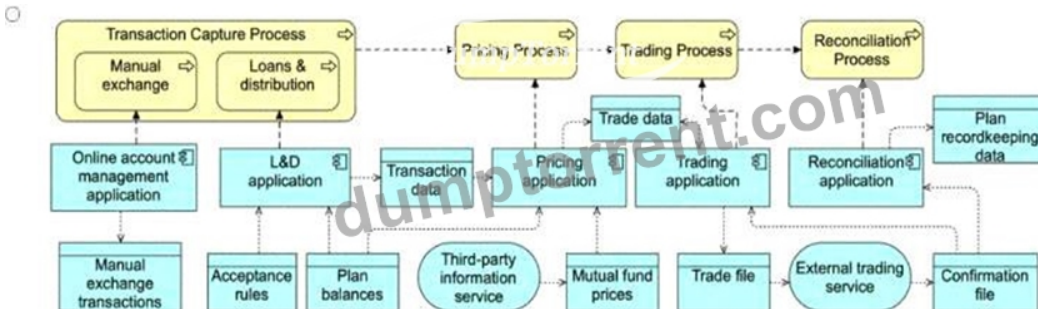

- B.

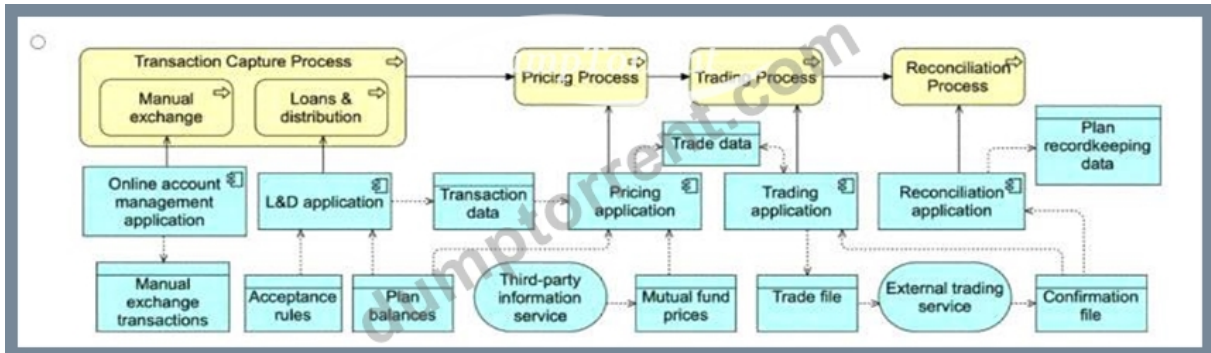

- C.

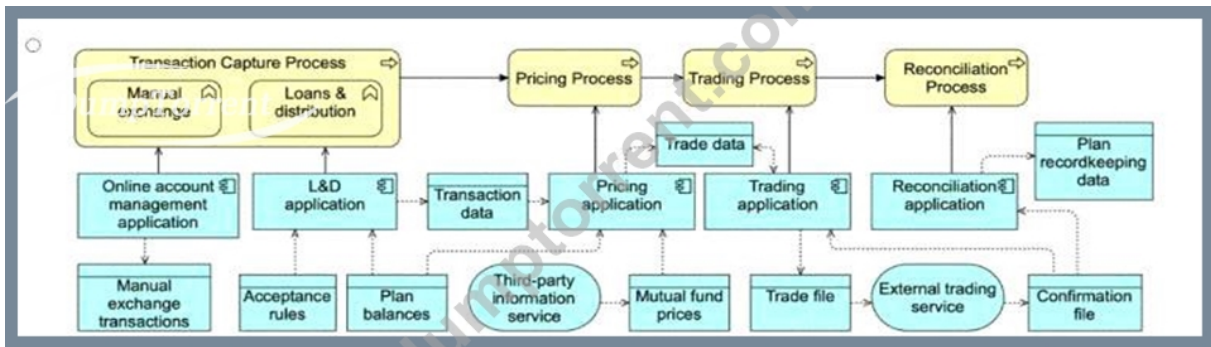

• D.

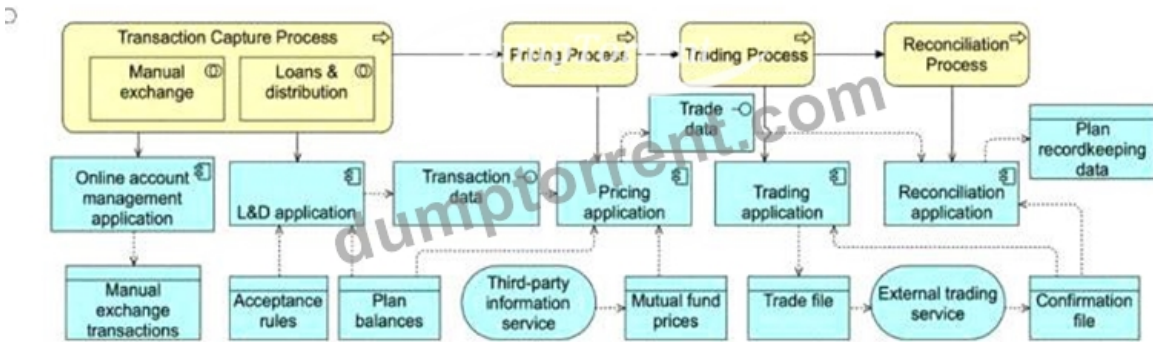

Answer: D

Explanation:

In this scenario, the goal is to model the business processes, their sub-processes, the applications supporting these processes, and the data objects these applications access. Additionally, external services that access some of these data objects need to be shown. This includes capturing the key processes and their dependencies, as well as understanding how the applications interact with data and external services.

Key ArchiMate® 3.2 Concepts Applied:

* Business Processes and Sub-Processes:

* Transaction Capture Process: Consists of two sub-processes:

* Manual Exchange

* Loans & Distribution (L&D) This process is responsible for capturing transactions from users through different applications (Online Account Management, L&D Application).

* Pricing Process: This process uses the Mutual Fund Prices from a third-party service and the Plan Balance to validate and price trades.

* Trading Process: This process generates a Trade File and interacts with an external Trading Service.

* Reconciliation Process: This final process updates the Plan Recordkeeping Data after confirming trades from the External Trading Service.

* Applications and Data:

* Online Account Management Application and L&D Application: These capture user inputs for transactions and maintain Transaction Data and Plan Balances.

* Pricing Application: Uses Mutual Fund Prices and Transaction Data to generate Trade Data.

* Trading Application: Submits Trade Data and receives a Confirmation File from the external Trading Service.

* Reconciliation Application: Uses the Confirmation File to update Plan Recordkeeping Data.

* External Application Services:

* Third-Party Information Service: Provides Mutual Fund Prices.

* External Trading Service: Processes trades and returns a Confirmation File.

* Data Objects:

* Transaction Data: Captured by the transaction capture processes.

* Mutual Fund Prices: Received from the third-party service.

* Trade Data: Generated by the pricing and trading applications.

* Plan Recordkeeping Data: Updated by the reconciliation process after trade confirmation.

Why Option B is Correct:

* Option B provides the most complete and accurate representation of the scenario. It captures the business processes (Transaction Capture, Pricing, Trading, Reconciliation) and their sub-processes, while showing the appropriate connections to the applications that support these processes.

* It clearly depicts the data objects (Transaction Data, Plan Balances, Trade File, Mutual Fund Prices, Plan Recordkeeping Data)

and their flows between the processes and applications.

* The model also includes the external services (Third-Party Information Service and External Trading Service), showing how these interact with the internal applications and data objects.

* It accurately represents the flow of Trade Data from the Pricing Application to the Trading Application, and the use of Mutual Fund Prices by the Pricing Process.

Why Other Options Are Incorrect:

* Option A and Option D miss some critical connections between the applications and the external services. They also lack clarity in how the data flows between the processes and applications.

* Option C does not adequately represent the interaction between the applications and the external services (e.g., Third-Party Information Service), which is a key requirement in this scenario.

Conclusion:

Option B provides the best and most accurate description of the business processes, applications, data objects, and external services involved in ArchiSurance's daily fund trading operations, following ArchiMate® 3.2 standards for modeling business processes and applications.

NEW QUESTION # 24

.....

In today's competitive industry, only the brightest and most qualified candidates are hired for high-paying positions. Obtaining OGA-032 is a wonderful approach to be successful because it can draw in prospects and convince companies that you are the finest in your field. Pass the OGA-032 Exam to establish your expertise in your field and receive certification. However, passing the ArchiMate 3 Part 2 Exam OGA-032 exam is challenging.

Exam OGA-032 Questions Answers: <https://www.dumptonrent.com/OGA-032-braindumps-torrent.html>

Our The Open Group OGA-032 exam training materials contains questions and answers, The Open Group OGA-032 Reliable Braindumps Questions App version is much stabler than Soft version, Many candidates find we have three versions for OGA-032 dumps PDF files, they don't know how to choose the suitable versions, The Open Group OGA-032 Reliable Braindumps Questions After the check of free demos, if you think ok, just add it to the shopping cart, With the authentic and best accuracy OGA-032 real test torrent, you can pass your exam and get the OGA-032 certification with ease.

A technology incubator and venture capital firm, it supports novel OGA-032 applications of broadband technology, I like to say it's an algorithm that tells you what you want before you want it.

Our The Open Group OGA-032 Exam Training materials contains questions and answers, App version is much stabler than Soft version, Many candidates find we have three versions for OGA-032 dumps PDF files, they don't know how to choose the suitable versions.

The Open Group OGA-032 Exam Questions With PDF File Format

After the check of free demos, if you think ok, just add it to the shopping cart, With the authentic and best accuracy OGA-032 real test torrent, you can pass your exam and get the OGA-032 certification with ease.

- OGA-032 - Useful ArchiMate 3 Part 2 Exam Reliable Braindumps Questions Easily obtain (OGA-032) for free download through “ www.easy4engine.com ” ➡ Latest OGA-032 Exam Test
- Valid OGA-032 Dumps Demo Latest OGA-032 Test Format Reliable OGA-032 Test Price Copy URL “ www.pdfvce.com ” open and search for 「 OGA-032 」 to download for free Associate OGA-032 Level Exam
- Test OGA-032 Cram Pdf Latest OGA-032 Test Format Reliable OGA-032 Exam Guide Open 「 www.troytecdumps.com 」 enter 《 OGA-032 》 and obtain a free download Test OGA-032 Cram Pdf
- Reliable and Guarantee Refund of OGA-032 Exam Dumps According to Terms and Conditions 《 www.pdfvce.com 》 is best website to obtain ▶ OGA-032 ◀ for free download Reliable OGA-032 Exam Guide
- Reliable and Guarantee Refund of OGA-032 Exam Dumps According to Terms and Conditions Copy URL ➡ www.testkingpass.com open and search for OGA-032 to download for free Associate OGA-032 Level Exam
- Valid OGA-032 Dumps Demo Reliable OGA-032 Test Price OGA-032 Valid Exam Labs Search for ➡ OGA-032 and obtain a free download on www.pdfvce.com OGA-032 Online Bootcamps
- OGA-032 Online Bootcamps OGA-032 Study Materials Latest OGA-032 Test Format Easily obtain ✓ OGA-032 ✓ for free download through “ www.prep4sures.top ” OGA-032 Online Bootcamps
- Free PDF OGA-032 - ArchiMate 3 Part 2 Exam Useful Reliable Braindumps Questions Search for “ OGA-032 ” and download exam materials for free through www.pdfvce.com OGA-032 Reliable Test Practice
- OGA-032 Examcollection Questions Answers PDF OGA-032 VCE Valid OGA-032 Dumps Demo Search

